

Flow Measurement

SITRANS F M

Flow sensor MAG 1100 F

Overview



The electromagnetic sensor SITRANS F M MAG 1100 F is designed to meet applications in the food and beverage industry.

Benefits

- Sensor sizes: DN 10 to DN 100 (3/8" to 4")
- AISI 316 stainless steel enclosure
- Sensor: Hygienic connection, 3A approval and EHEDG certified
- Sanitary design for CIP / SIP cleaning
- Conforms to FDA
- Easy commissioning, the SENSORPROM unit automatically updates settings
- Hose proof IP67/NEMA 4X enclosure rating
- Designed that patented in-situ verification can be conducted. Using SENSORPROM fingerprints

Application

The main applications of the SITRANS F M electromagnetic sensors can be found in the following fields:

- Food industry
- Beverage industry
- Pharmaceutical industry

Design

- Unique mechanical design with a wide range of customer specified sanitary connection
- Compact or remote mounting possible easy "plug & play" field changeable
- Simple on site upgrade to IP68/NEMA 6P terminal box
- Ex ATEX 2G D version for hazardous areas (ceramic liner)

Mode of operation

The flow measuring principle is based on Faraday's law of electromagnetic induction according to which the sensor converts the flow into an electrical voltage proportional to the velocity of the flow.

Integration

The complete flowmeter consists of a sensor and an associated transmitter SITRANS F M MAG 5000, 6000 and 6000 I. The flexible communication concept USM II simplifies integration and update to a variety of fieldbus systems such as PROFIBUS DP and PA, Modbus RTU/RS485, HART, FOUNDATION Fieldbus H1, DeviceNet.

Pressure/temperature curve; material AISI 316L/1.4404

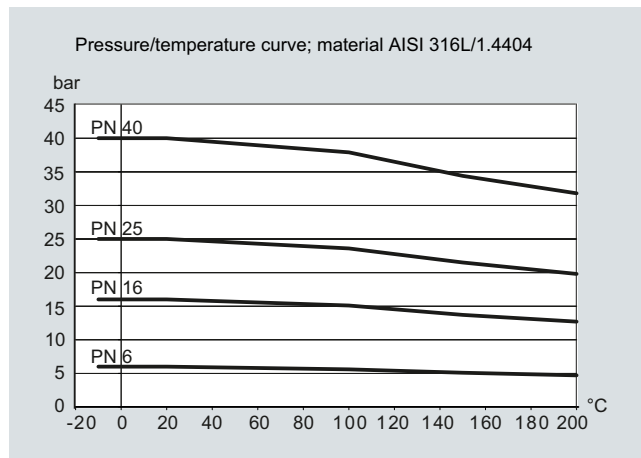

Pressure/temperature curve; material AISI 316L/1.4404

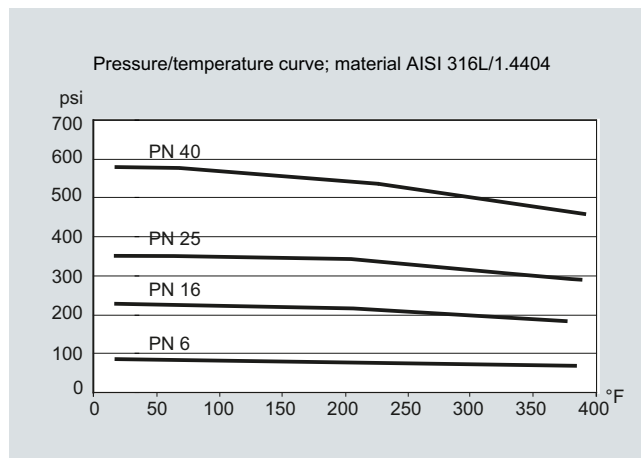

For further information on the PED standard and requirements, see page 10/9.

Technical specifications

Measuring principle Excitation frequency (Mains supply: 50 Hz/60 Hz)	Electromagnetic induction DN 10 ... 65 (1/4" ... 2 1/2"): 12.5 Hz/15 Hz DN 80 ... 100 (3", 4"): 6.25 Hz/7.5 Hz
Process connection Nominal size Process connection	DN 10 ... DN 100 (3/8" ... 4") Hygienic adapters available for: • Direct welding onto pipe • Clamp fitting • Threaded fitting
Rated operating conditions <u>Ambient conditions</u> Ambient temperature ¹⁾ • Sensor • Ex sensor • Compact transmitter MAG 5000/6000 ²⁾ • Transmitter MAG 6000 I • Compact transmitter MAG 6000 I Ex de	-40 ... +100 °C (-40 ... +212 °F) -20 ... +60 °C (-4 ... +140 °F) -20 ... +60 °C (-4 ... +140 °F) -20 ... +60 °C (-4 ... +140 °F) -10 ... +60 °C (14 ... 140 °F)
<u>Temperature of medium</u> MAG 1100 F (Ceramic) MAG 1100 F (PFA)	-20 ... +150 °C (-4 ... +302 °F) Suitable for steam sterilization -30 ... +130 °C (-22 ... +266 °F) Suitable for steam sterilization at 150 °C (302 °F)
<u>Temperature shock</u> MAG 1100 F • Duration ≤ 1 min, followed by 10 min rest	• DN 10, 15, 25: Max. ΔT ≤ 80 °C/min (3/8", 1/2", 1"): Max. ΔT ≤ 144 °F/min) • DN 40, 50, 65: Max. ΔT ≤ 70 °C/min (1 1/2", 2", 2 1/2"): Max. ΔT ≤ 126 °F/min) • DN 80, 100: Max. ΔT ≤ 60 °C/min (3", 4"): Max. ΔT ≤ 108 °F/min) Max. ± 100 °C (212 °F) momen- tarily
<u>Operating pressure</u> MAG 1100 F (Ceramic) MAG 1100 F (PFA)	DN 10 ... 65: 40 bar (3/8" ... 2 1/2"): 580 psi) DN 80: 25 bar (3": 363 psi) DN 100: 25 bar (4": 363 psi) Vacuum: 1 x 10 ⁻⁶ bar _{abs} (1.5 x 10 ⁻⁵ psi _{abs}) 20 bar (290 psi) Vacuum: 0.02 bar _{abs} (0.3 psi _{abs}) DN 80 ... DN 100: CO ₂ pressure max. 7 bar (101.5 psi)
<u>Mechanical load (vibration)</u>	18 ... 1000 Hz random in x, y, z, directions for 2 hours according to EN 60068-2-36 Sensor: 3.17 grms Sensor with compact MAG 5000/ 6000 mounted transmitter: 3.17 gr. Sensor with compact MAG 6000 I/MAG 6000 I Ex mounted transmitter: 1.14 grms For compact installation with the MAG 6000 I/MAG 6000 I Ex, transmitter to be supported to avoid tension on sensor part.
<u>Enclosure rating</u>	IP67 to EN 60529 (NEMA 4X), 1 mH ₂ O for 30 min
EMC	2004/108/EC

Design Weight	See Dimensional drawings
<u>Material</u> Enclosure	Stainless steel AISI 316L/1.4404
• MAG 1100 F Terminal box (remote version only)	Fibre glass reinforced polyamide Stainless steel AISI 316/1.4436
• Standard • Option • Ex ATEX (remote version only)	Stainless steel AISI 316/1.4436
Liner MAG 1100 F (Ceramic) MAG 1100 F (PFA)	Aluminum oxide Al ₂ O ₃ (ceramics) Reinforced PFA (teflon) (not for Ex)
Electrodes MAG 1100 F (Ceramic) MAG 1100 F (PFA)	Platinum with gold /Titanium brazing alloy • DN 10 ... 15 (3/8" ... 1/2"): Hastelloy C276/2.4819 • DN 25 ... 100 (1" ... 4"): Hastelloy C22/2.4602
Cable entries	• Remote installation 2 x M20 or 2 x 1/2" NPT • Compact installation - MAG 5000/MAG 6000: 4 x M20 or 4 x 1/2" NPT - MAG 6000 I: 2 x M25 (for sup- ply/output) - MAG 6000 I Ex de: 2 x M25 (for supply/output)
Certificates and approvals Calibration	Zero-point, 2 x 25 %, 2 x 90 %
• Standard Production calibration, calibration report shipped with sensor MAG 1100 F (Ceramic)	3A (sensor with Polyamide termi- nal box and FKM/FPM gaskets), transmitter not part of the approval
• Ex ATEX approvals for sensor or compact with MAG 6000 I Ex • Sensor with/without MAG 5000/6000/6000 I MAG 1100 F (PFA)	ATEX 2G D sensor EEx d e ia IIB T3 - T6 FM Class I, Div 2 3A (sensor with Polyamide termi- nal box with EPDM gasket), trans- mitter not part of the approval EHEDG certified (use EPDM P-seal) (DN 25 ... 100 (1 ... 4")) FM Class I, Div 2
Conforms to	• PED – 97/23/EC ³⁾ • CRN (PFA) • FDA
Custody transfer approvals (MAG 5000/6000 CT)	• Cold water pattern approval PTB (Germany) • Hot water pattern approval PTB (Germany) • Other media than water pattern approval- OIML R 117 (Ceramic liner)(Denmark)

- 1) Conditions are also dependent on liner characteristics.
- 2) With compact transmitter MAG 5000 CT/6000 CT -20 ... +50 °C
- 3) For further information on the PED standard and requirements, see page 10/9.

Flow Measurement

SITRANS F M

Flow sensor MAG 1100 F

Accessories

Weld-in adapter

Adapter for welding onto dairy pipe Tri-Weld, ISO 2037, DIN 11850, SMS 3008, BS 4825-1

- DN 10, 15, 25, 40, 50 and 65 (3/8", 1/2", 1", 1 1/2", 2" and 2 1/2") PN 40 (600 psi)
- DN 80 and DN 100 (3" and 4") PN 25 (350 psi)

Clamp adapter

Tri-Clamp, ISO 2852, DIN 32676, SMS 3016, BS 4825-3

- DN 10, 15, 25, 40 and 50 (3/8", 1/2", 1", 1 1/2", and 2") PN 16 (200 psi)
- DN 65, 80 and 100 (2 1/2", 3" and 4") PN 10 (150 psi)

Thread adapter

DIN 11851

- DN 10, 15, 25, and 40 (3/8", 1/2", 1", and 1 1/2") PN 40 (600 psi)
- DN 50, 65, 80 and 100 (2", 2 1/2", 3" and 4") PN 25 (350 psi)

ISO 2853, BS 4825-4

- DN 10, 15, 25, 40, 50, 65 and 80 (3/8", 1/2", 1", 1 1/2", 2", 2 1/2" and 3") PN 16 (200 psi)

SMS 1145

- DN 25, 40, 50, 65 and 80 (1", 1 1/2", 2", 2 1/2" and 3") PN 6 (80 psi)

Design

Material

Adapter Stainless steel AISI 316/1.4436

Gasket

- MAG 1100 F (Ceramic) FKM/FPM with stainless steel insert (AISI 304/1.4301) (-20 ... +150 °C (-4 ... +302 °F))
- MAG 1100 F (PFA) EPDM (-20 ... +150 °C (-4 ... +302 °F))
NBR (-20 ... +100 °C (-4 ... +212 °F))

Note:

When combined sensor and adapter, the operating pressure is the lower rated of the pair.

Selection and Ordering data

Order No.

Sensor SITRANS F M MAG 1100 F

7ME6140-

Diameter

- DN 10 (3/8") ◆ 1 R
- DN 15 (1/2") ◆ 1 V
- DN 25 (1") ◆ 2 D
- DN 40 (1 1/2") ◆ 2 R
- DN 50 (2") ◆ 2 Y
- DN 65 (2 1/2") ◆ 3 F
- DN 80 (3") ◆ 3 M
- DN 100 (4") ◆ 3 T

Process connections

No adaptors (specials see accessories) ◆ A

Weld in

- DIN 11850 ◆ B
- ISO 2037 (SMS 3008) ◆ C
- BS 4825-1 ◆ D
- Tri-Weld ◆ E

Clamp type

- DIN 32676 ◆ G
- ISO 2852 (SMS 3016) ◆ H
- BS 4825-3 ◆ J
- Tri-Clamp ◆ K

Threaded type

- DIN 11851 ◆ M
- SMS 1145 ◆ N

Liner material

- PFA (not for Ex) ◆ 1
- Ceramic ◆ 2

Gasket material

- EPDM flat gasket (FDA) ◆ 0
- FPM/FKM (FDA) (only with ceramic liner) ◆ 2
- EPDM-P gasket (only for PFA) (FDA, EHEDG certified, 3A pending) ◆ 3

Electrode material

- Hastelloy C (only with PFA liner) ◆ 1
- Platinum (only with ceramic liner) ◆ 2

Transmitter

- Standard sensor for remote transmitter (order transmitter separately) 3A ◆ A
- Ex sensor for remote transmitter (order transmitter separately) 3A ◆ B
- MAG 6000 I, Alu.18 ... 90 V DC, 115 ... 230 V AC ◆ C
- MAG 6000 I, Aluminum 18 ... 30 V DC, Ex ◆ D
- MAG 6000 I, Aluminum 115 ... 230 V AC, Ex ◆ E
- MAG 6000, Polyamide, 11 ... 30 V DC/11 ... 24 V AC ◆ H
- MAG 6000, Polyamide, 115 ... 230 V AC ◆ J
- MAG 5000, Polyamide, 11 ... 30 V DC/11 ... 24 V AC ◆ K
- MAG 5000, Polyamide, 115 ... 230 V AC ◆ L

Communication

- No communication, add-on possible ◆ A
- HART ◆ B
- PROFIBUS PA Profile 3 (only MAG 6000/MAG 6000 I) ◆ F
- PROFIBUS DP Profile 3 (not for Ex) (only MAG 6000/MAG 6000 I) ◆ G
- Modbus RTU/RS 485 (not for Ex) (only MAG 6000/MAG 6000 I) ◆ E
- FOUNDATION Fieldbus H1 (only MAG 6000/MAG 6000 I) ◆ J

Selection and Ordering data	Order No.
Sensor SITRANS F M MAG 1100 F	7ME6140-
Cable glands/terminal box	
Metric: Polyamide terminal box or 6000 I compact	1
½" NPT: Polyamide terminal box or 6000 I compact	2
Metric: SS terminal box (mandatory for Stainless steel MAG 6000 Transmitter)	3
½" NPT: SS terminal box (mandatory for Stainless steel MAG 6000 Transmitter)	4
◆ Short lead time (details in PMD)	

Selection and Ordering data	Order code
Additional information	
Please add "-Z" to Order No. and specify Order code(s) and plain text.	
Customer-specific converter setup	Y20
Tag name plate, stainless steel fixed with SS wire (add plain text)	Y17
Tag name plate, plastic (self adhesive)	Y18
Factory certificate according to EN 10204-2.1	C15
Factory certificate according to EN 10204-2.2	C14
Sensor cables wired (specify cable order no.)	Y40
Sensor for remote transmitter's junction box potted with wired cable (specify cable order no.) (not for Ex sensors)	Y41
Other postproduction requirements (add desired text)	Y99
Additional calibrations	
• Matched pair - (Standard production calibration where sensor and transmitter is calibrated together)	On request¹⁾
• Customer-specified calibration up to 10 points	On request¹⁾
• Customer-witnessed calibration Any of above calibration	On request¹⁾

¹⁾ Ordering "On request" as dedicated information from the customer on the individual sensors is required. Please fill in the calibration form found on <http://intranet.automation.siemens.com/w1/automation-technology-flow-measurement-18626.htm#content-19336¶1=Flow%20Measurement> and send together with the order. (Size dependent restriction on maximum flow rates may apply)

Operating instructions for SITRANS F M MAG 1100F

Description	Order No.
Handbook	
• English	A5E02435647

This device is shipped with a Quick Start guide and a CD containing further SITRANS F literature.

All literature is also available for free at:
<http://www.siemens.com/flowdocumentation>

MAG 5000/6000 transmitters and sensors are packed in separate boxes, the final assembly takes place during installation at the customer's place. MAG 6000 I/MAG 6000 I Ex ATEX 2G D transmitters and sensors are delivered compact mounted from factory. Communication module will be pre-mounted in the transmitter.

Please use online Product selector to get latest updates.
Product selector link:
www.pia-selector.automation.siemens.com

Please also see www.siemens.com/SITRANSOrdering for practical examples of ordering

Accessories

Description	Order No.
Potting kit for IP68/NEMA 6P terminal box (not for Ex)	◆ FDK-085U0220



◆ Short lead time (details in PMD)

Flow Measurement

SITRANS F M

Flow sensor MAG 1100 F

Accessories

Order No.

Weld in connection fittings for MAG 1100 F with P gaskets for EHEDG

Only for sensors with PFA liner.

2 pcs. fittings
2 pcs. clamps (to join flow sensor and fitting)

DIN 11850

Adapter		Sensor	
DN (mm)	D _o (mm)	D _i (mm)	DN (mm)

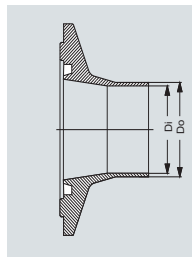

10	13	10	10	◆ A5E02054630
15	19	16	15	◆ A5E02054633
20	23	20	15	A5E02054634
25	29	26	25	◆ A5E02054635
32	35	32	25	A5E02054637
40	41	38	40	◆ A5E02054638
50	53	50	50	◆ A5E02054640
65	70	66	65	◆ A5E02054643
80	85	81	80	◆ A5E02054644
100	104	100	100	◆ A5E02054646

ISO 2037 (SMS3008)

Adapter		Sensor	
DN (mm)	D _o (mm)	D _i (mm)	DN (mm)

10	13	10	10	◆ A5E02054630
15	19	16	15	◆ A5E02054633
25	25.6	22.6	25	◆ A5E02196073
28	28.6	25.6	25	A5E02196074
38	38.6	35.6	40	◆ A5E02196075
40	40.6	37.6	40	◆ A5E02196076
51	51.6	48.6	50	◆ A5E02196077
63.5	64.1	60.3	65	◆ A5E02196078
76.1	76.7	72.9	80	◆ A5E02196080
101.6	102.5	97.6	100	A5E02196082

Tri-Weld (BS 4825-1)

Adapter		Sensor	
DN (mm)	D _o (mm)	D _i (mm)	DN (mm)

10	12.7	9.4	10	A5E02199113
15.9	19.05	15.75	15	A5E02199114
25	25.4	22.1	25	A5E02199115
38	38.1	34.8	40	A5E02199116
51	50.8	47.5	50	A5E02199117
63.5 ¹⁾	63.5	60.2	65	A5E02199118
76.1	76.2	72.9	80	A5E02199119
102 ¹⁾	101.6	97.38	100	A5E02199120

◆ Short lead time (details in PMD)

D_o: outer diameterD_i: inner diameter¹⁾ For BS 4825-1 see ISO 2037

Accessories

Order No.

Clamp-type connection fittings for MAG 1100 F with P gaskets for EHEDG

Only for sensors with PFA liner.

2 pcs. fittings
2 pcs. clamps (to join flow sensor and fitting)

DIN 32676

Adapter		Sensor	
DN (mm)	D _o (mm)	D _i (mm)	DN (mm)

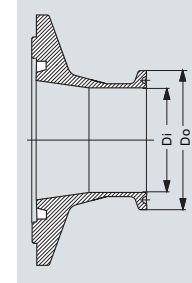

10	34	10	10	A5E02211143
15	34	16	15	A5E02211144
25	50.5	26	25	A5E02211146
40	50.5	38	40	A5E02211147
50	64	50	50	A5E02211148
65	91	66	65	A5E02211151
80	106	81	80	A5E02211152
100	119	100	100	A5E02211153

ISO 2852 (SMS 3016, BS 4825-3)

Adapter		Sensor	
DN (mm)	D _o (mm)	D _i (mm)	DN (mm)

10	34	10	10	A5E02211143
15	34	16	15	A5E02211144
25	50.5	26	25	A5E02213581
33.7	50.5	31.3	25	A5E02213582
38	50.5	35.6	40	A5E02213583
51	64	48.6	50	A5E02213584
63.5	77.5	60.3	65	A5E02213585
76.1	91	72.9	80	A5E02213586
101.6	119	97.6	100	A5E02213587

Tri-Clamp

Adapter		Sensor	
DN (mm)	D _o (mm)	D _i (mm)	DN (mm)

10	25	10	10	A5E02213596
15	25	16	15	A5E02213597
25	50.5	22.6	25	A5E02213598
38	50.5	35.6	40	A5E02213599
51	64	48.6	50	◆ A5E02213600
63.5	77.5	60.3	65	A5E02213601
76.1	91	72.9	80	◆ A5E02213602
101.6	119	97.6	100	A5E02213603

◆ Short lead time (details in PMD)

D_o: outer diameterD_i: inner diameter

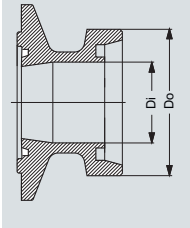
Accessories				Order No.
Threaded type connection fittings for MAG 1100 F with P gaskets for EHEDG				
Only for sensors with PFA liner.				
2 pcs. fittings				
2 pcs. clamps (to join flow sensor and fitting)				
DIN 11851				
<u>Adapter</u>		<u>Sensor</u>		
DN (mm)	D _o (mm)	D _i (mm)	DN (mm)	
				
10	28	10	10	A5E02218293
15	34	16	15	A5E02218294
20	44	20	15	A5E02218295
25	52	26	25	◆ A5E02218296
32	58	32	25	A5E02218297
40	65	38	40	◆ A5E02218298
50	78	50	50	◆ A5E02218299
65	95	66	65	A5E02218300
80	110	81	80	A5E02218301
100	130	100	100	A5E02218302

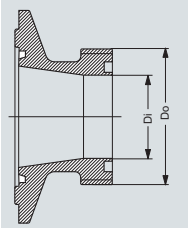
Accessories				Order No.
Threaded type connection fittings for MAG 1100 F with P gaskets for EHEDG				
Only for sensors with PFA liner.				
2 pcs. fittings				
2 pcs. clamps (to join flow sensor and fitting)				
SMS 1145				
<u>Adapter</u>		<u>Sensor</u>		
DN (mm)	D _o (mm)	D _i (mm)	DN (mm)	
				
25	40	22.6	25	A5E02218310
38	60	35.6	40	A5E02218312
51	70	48.6	50	A5E02218313
63.5	85	60.3	65	A5E02218314
76	98	72	65	A5E02218315
◆ Short lead time (details in PMD)				
D _o : outer diameter				
D _i : inner diameter				

Flow Measurement

SITRANS F M

Flow sensor MAG 1100 F

Accessories

Order No.

Weld in connection fittings for MAG 1100 F with flat gaskets for 3A

For sensors with ceramic and PFA liner.

2 pcs. fittings
2 pcs. clamps (to join flow sensor and fitting)

DIN 11850

Adapter		Sensor	
DN (mm)	D _o (mm)	D _i (mm)	DN (mm)

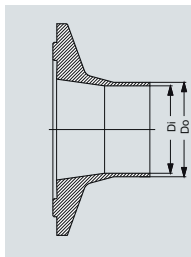

10	13	10	10	◆ FDK-083G2116
15	19	16	15	◆ FDK-083G2117
20	23	20	15	◆ FDK-083G2118
25	29	26	25	◆ FDK-083G2119
32	35	32	25	◆ FDK-083G2120
40	41	38	40	◆ FDK-083G2121
50	53	50	50	◆ FDK-083G2122
65	70	66	65	◆ FDK-083G2123
80	85	81	80	◆ FDK-083G2124
100	104	100	100	◆ FDK-083G2125

ISO 2037 (SMS3008)

Adapter		Sensor	
DN (mm)	D _o (mm)	D _i (mm)	DN (mm)

10	13	10	10	◆ FDK-083G2116
15	19	16	15	◆ FDK-083G2117
25	25.6	22.6	25	◆ FDK-083G2109
28	28.6	25.6	25	◆ FDK-083G2100
38	38.6	35.6	40	◆ FDK-083G2111
40	40.6	37.6	40	◆ FDK-083G2101
51	51.6	48.6	50	◆ FDK-083G2112
63.5	64.1	60.3	65	◆ FDK-083G2113
76.1	76.7	72.9	80	◆ FDK-083G2114
101.6	102.5	97.6	100	◆ FDK-083G2115
114.3	115.6	110.3	100	◆ FDK-083G2105

Tri-Weld (BS 4825-1)

Adapter		Sensor	
DN (mm)	D _o (mm)	D _i (mm)	DN (mm)

10	12.7	9.4	10	◆ FDK-083G2276
15.9	19.05	15.75	15	◆ FDK-083G2277
25	25.4	22.1	25	◆ FDK-083G2279
38	38.1	34.8	40	◆ FDK-083G2281
51	50.8	47.5	50	◆ FDK-083G2282
63.5 ¹⁾	63.5	60.2	65	◆ FDK-083G2283
76.1	76.2	72.9	80	◆ FDK-083G2284
102 ¹⁾	101.6	97.38	100	◆ FDK-083G2285

◆ Short lead time (details in PMD)

D_o: outer diameterD_i: inner diameter¹⁾ For BS 4825-1 see ISO 2037

Accessories

Order No.

Clamp-type connection fittings for MAG 1100 F with flat gaskets for 3A

For sensors with ceramic and PFA liner.

2 pcs. fittings
2 pcs. clamps (to join flow sensor and fitting)

DIN 32676

Adapter		Sensor	
DN (mm)	D _o (mm)	D _i (mm)	DN (mm)

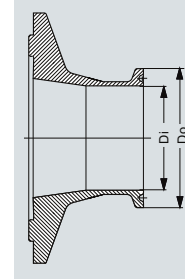

10	34	10	10	◆ FDK-083G2186
15	34	16	15	◆ FDK-083G2187
25	50.5	26	25	◆ FDK-083G2179
40	50.5	38	40	◆ FDK-083G2181
50	64	50	50	◆ FDK-083G2182
65	91	66	65	◆ FDK-083G2183
80	106	81	80	◆ FDK-083G2184
100	119	100	100	◆ FDK-083G2185

ISO 2852 (SMS 3016, BS 4825-3)

Adapter		Sensor	
DN (mm)	D _o (mm)	D _i (mm)	DN (mm)

10	34	10	10	◆ FDK-083G2186
15	34	16	15	◆ FDK-083G2187
25	50.5	26	25	◆ FDK-083G2179
33.7	50.5	31.3	25	◆ FDK-083G2190
38	50.5	35.6	40	◆ FDK-083G2191
51	64	48.6	50	◆ FDK-083G2192
63.5	77.5	60.3	65	◆ FDK-083G2193
76.1	91	72.9	80	◆ FDK-083G2194
101.6	119	97.6	100	◆ FDK-083G2195

Tri-Clamp

Adapter		Sensor	
DN (mm)	D _o (mm)	D _i (mm)	DN (mm)

10	25	10	10	◆ FDK-083G2286
15	25	16	15	◆ FDK-083G2287
25	50.5	22.6	25	◆ FDK-083G2289
38	50.5	35.6	40	◆ FDK-083G2291
51	64	48.6	50	◆ FDK-083G2292
63.5	77.5	60.3	65	◆ FDK-083G2293
76.1	91	72.9	80	◆ FDK-083G2294
101.6	119	97.6	100	◆ FDK-083G2295

◆ Short lead time (details in PMD)

D_o: outer diameterD_i: inner diameter

Accessories

Order No.

Threaded type connection fittings for MAG 1100 F with flat gaskets for 3A

For sensors with ceramic and PFA liner.

2 pcs. fittings

2 pcs. clamps (to join flow sensor and fitting)

DIN 11851

Adapter			Sensor
DN (mm)	D _o (mm)	D _i (mm)	DN (mm)

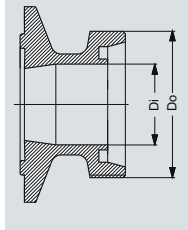

10	28	10	10	FDK-083G2156
15	34	16	15	FDK-083G2157
20	44	20	15	FDK-083G2158
25	52	26	25	◆ FDK-083G2159
32	58	32	25	FDK-083G2160
40	65	38	40	◆ FDK-083G2161
50	78	50	50	◆ FDK-083G2162
65	95	66	65	FDK-083G2163
80	110	81	80	FDK-083G2164
100	130	100	100	FDK-083G2165

ISO 2853

Adapter			Sensor
DN (mm)	D _o (mm)	D _i (mm)	DN (mm)

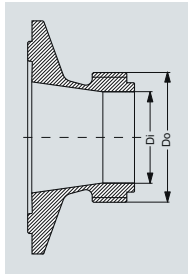

25	37	22.6	25	FDK-083G2149
38	51	35.6	40	FDK-083G2151
51	64	48.6	50	FDK-083G2152
63.5	78	60.3	65	FDK-083G2153
76.1	91	72.9	80	FDK-083G2154
101.6	118	97.6	100	FDK-083G2155

BS 4825-4

Adapter			Sensor
DN (mm)	D _o (mm)	D _i (mm)	DN (mm)

25	37	22.6	25	FDK-083G2149
38	51	35.6	40	FDK-083G2151
51	64	48.6	50	FDK-083G2152
63.5	78	60.3	65	FDK-083G2153
76.1	91	72.9	80	FDK-083G2154
101.6	126	97.6	100	FDK-083G2145

Accessories

Order No.

Threaded type connection fittings for MAG 1100 F with flat gaskets for 3A

For sensors with ceramic and PFA liner.

2 pcs. fittings

2 pcs. clamps (to join flow sensor and fitting)

SMS 1145

Adapter			Sensor
DN (mm)	D _o (mm)	D _i (mm)	DN (mm)

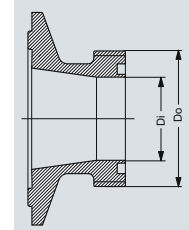

25	40	22.6	25	FDK-083G2139
38	60	35.6	40	FDK-083G2141
51	70	48.6	50	FDK-083G2142
63.5	85	60.3	65	FDK-083G2143
76	98	72	65	FDK-083G2144

◆ Short lead time (details in PMD)

D_o: outer diameterD_i: inner diameter

Flow Measurement

SITRANS F M

Flow sensor MAG 1100 F

Spare parts for MAG 1100 F

Order No.

Gaskets

(2 pcs., between flow sensor and adapter)

MAG 1100 F (PFA) - P gaskets

Rubber: EPDM (FDA)

• DN 10	◆ A5E02055286
• DN 15	◆ A5E02055287
• DN 25	◆ A5E02055290
• DN 40	◆ A5E02055291
• DN 50	◆ A5E02055292
• DN 65	◆ A5E02055293
• DN 80	◆ A5E02055295
• DN 100	◆ A5E02055297

MAG 1100 F (ceramic) - flat gaskets

Rubber: FKM/FPM (FDA)

• DN 10	◆ A5E00915707
• DN 15	◆ A5E00915764
• DN 25	◆ A5E00915771
• DN 40	◆ A5E00915773
• DN 50	◆ A5E00915775
• DN 65	◆ A5E00915780
• DN 80	◆ A5E00915782
• DN 100	◆ A5E00915784

MAG 1100 F (PFA) - flat gaskets

Rubber: EPDM (FDA)

• DN 10	◆ FDK-083G2206
• DN 15	◆ FDK-083G2207
• DN 25	◆ FDK-083G2209
• DN 40	◆ FDK-083G2211
• DN 50	◆ FDK-083G2212
• DN 65	◆ FDK-083G2213
• DN 80	◆ FDK-083G2214
• DN 100	◆ FDK-083G2215

Rubber: NBR

• DN 10	FDK-083G2216
• DN 15	FDK-083G2217
• DN 25	FDK-083G2219
• DN 40	FDK-083G2221
• DN 50	FDK-083G2222
• DN 65	FDK-083G2223
• DN 80	FDK-083G2224
• DN 100	FDK-083G2225

◆ Short lead time (details in PMD)

4

Dimensional drawings

Sensor MAG 1100 F compact/remote

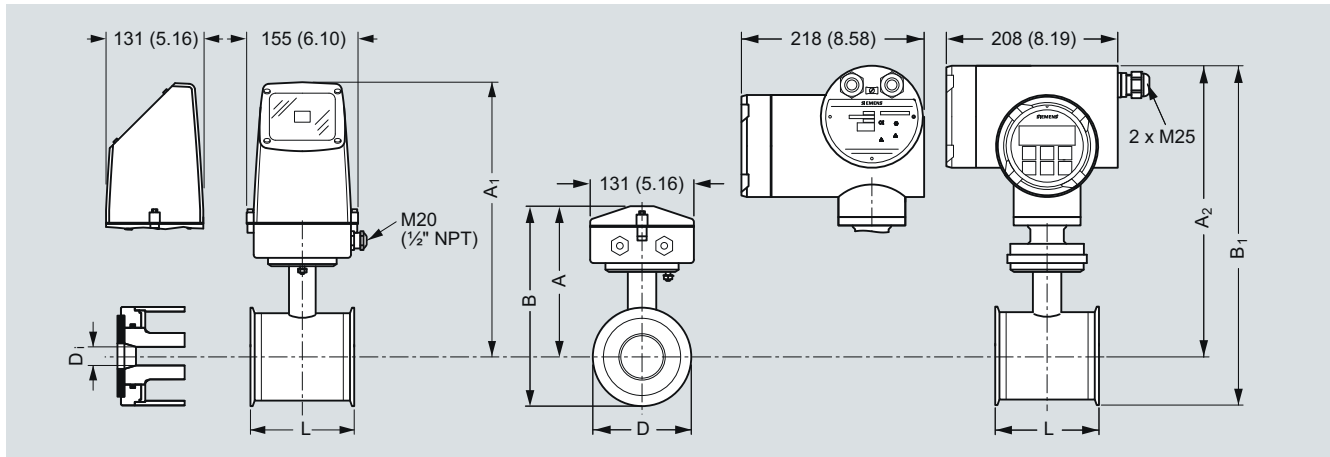

Dimensions in mm (inch)

Important note:

For compact installation with MAG 6000 I/Ex - transmitter to be supported to avoid tension on the sensor part.

Size	L	A	A ₁ ³⁾	B ²⁾	B ₁	D	D ₁ (Al ₂ O ₃)	D ₁ PFA	Weight ¹⁾
DN	[mm]	[mm]	[mm]	[mm]	[mm]	[mm]	[mm]	[mm]	[kg]
10	64	161	315	193.7	344.7	64.0	10	10	2.2
15	64	161	315	193.7	344.7	64.0	15	16	2.2
25	79	169	323	207.5	359.0	77.5	25	26	2.7
40	94	179	333	228.0	379.0	91.0	40	38	3.4
50	104	188	342	247.7	398.7	119.0	50	50	4.2
65	131	197.5	351	262.6	413.6	130.0	65	66	5.5
80	156	204	357	281.0	432.0	155.0	80	81	7.0
100	186	217	370	308.0	459.0	183.0	100	100	10.0

Size	L	A	A ₁ ³⁾	B ²⁾	B ₁	D	D ₁ (Al ₂ O ₃)	D ₁ PFA	Weight ¹⁾
[inch]	[inch]	[inch]	[inch]	[inch]	[inch]	[inch]	[inch]	[inch]	[lb]
3/8	2.52	6.34	12.40	7.62	13.57	2.52	0.39	0.39	4.8
1/2	2.52	6.34	12.40	7.62	13.57	2.52	0.59	0.63	4.8
1	3.11	6.66	12.72	8.17	14.13	3.05	0.98	1.02	4.9
1 1/2	3.70	7.05	13.11	8.98	14.92	3.58	1.57	1.50	7.5
2	4.09	7.40	13.47	9.75	15.70	4.68	1.97	1.97	9.2
2 1/2	5.16	7.78	13.82	10.34	16.28	5.12	2.56	2.60	12.0
3	6.14	8.03	14.06	11.06	17.01	6.10	3.15	3.19	15.0
4	7.32	8.54	14.57	12.13	18.07	7.20	3.94	3.94	22.0

¹⁾ With transmitter MAG 5000 or MAG 6000 compact, weight is increased by approximately 0.8 kg (1.8 lb)

With MAG 6000 I weight is increased with 5.5 kg (12.1 lbs)

²⁾ 14.5 mm (0.571") shorter when the AISI terminal box is used (always Ex version)

³⁾ A₂ is 3 mm (0.12") shorter than A₁

Flow Measurement

SITRANS F M

Flow sensor MAG 1100 F

Sensor MAG 1100 F compact/separate – build-in length

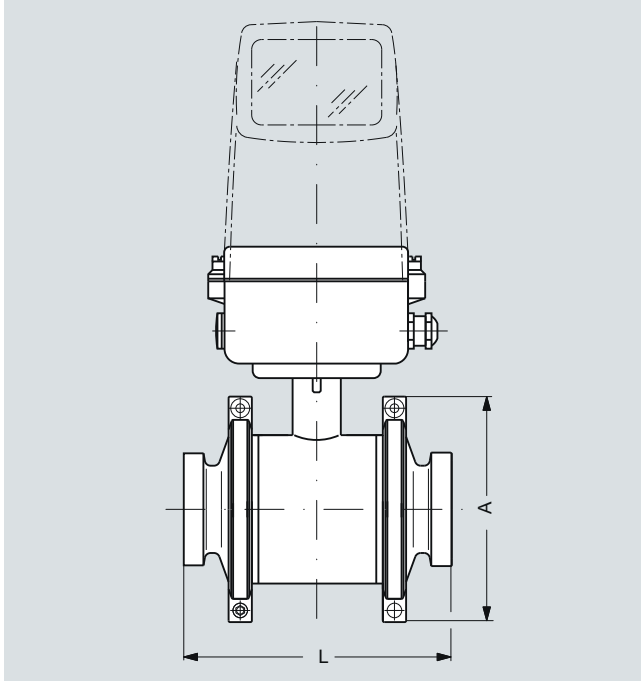

4

Size		A		L ¹⁾	
DN	inch	[mm]	[inch]	[mm]	[inch]
10	3/8	99	3.90	146	5.75
15	1/2	99	3.90	146	5.75
25	1	113	4.45	161	6.34
40	1 1/2	126	4.96	176	6.93
50	2	154	6.06	186	7.32
65	2 1/2	165	6.50	223	8.78
80	3	200	7.87	258	10.16
100	4	225	8.86	288	11.34

¹⁾ The total build-in length "L" is independent of the adapter type selected.